









# Assemble instruction

GLS-63356-21KD

Part List:

NO.	Picture	Name	Qty
A		Seat	1
B		Leg	1
C		Steel Washer	4
D		M6X30MM Bolt	4
E		PVC Bolt Cover	4
F		Wrench	1
G		Back Cushion	1
H		Seat Cushion	1

**STEP 1**

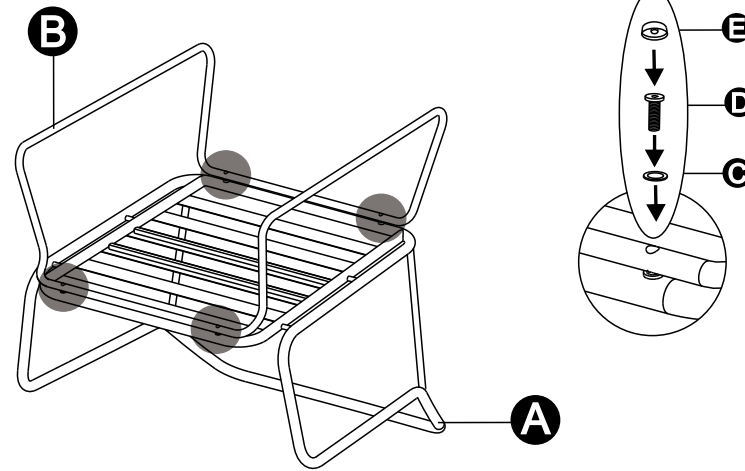

**STEP 2**

